

FR12-32 Flow Regulator, Orifice Adjustable,

Patent Pending

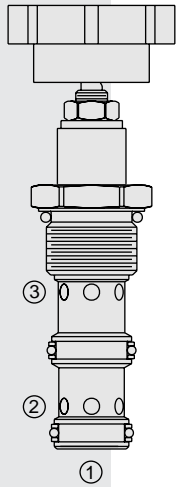

DESCRIPTION

A manually adjustable, pressure-compensated, bi-directional flow control valve. An internal compensator spool provides compensated flow across the proportional orifice regardless of flow direction.

OPERATION

The **FR12-32** provides regulated flow in both directions: from port ② to port ③, or from port ③ to port ②. Port ① should be blocked. Regulated flow increases from closed to fully open with clockwise rotation. The valve will maintain the set flow rate regardless of pressure variations at each of the ports.

FEATURES

- Excellent linearity and hysteresis characteristics.
- Hardened spool and cage for long life.
- Various adjustment options.

RATINGS

Maximum Operating Pressure: 240 bar (3500 psi)

Regulated Flow: 0-50 lpm (0-13 gpm)

Internal Leakage: 0.38 lpm (0.10 gpm) maximum

Temperature: -40 to 120°C with Buna N seals

Filtration: See page 9.010.1

Fluids: Mineral-based or synthetics with lubricating properties at viscosities of 7.4 to 420 cSt (50 to 2000 sus); See Temperature and Oil Viscosity, page 9.060.1

Installation: No restrictions; See page 9.020.1.

Cavity: VC12-3; See page 9.112.1

Cavity Tool: CT12-3X-XX; See page 8.600.1

Seal Kit: SK12-3X-MM; See page 8.650.1

SYMBOLS

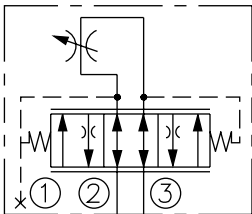

ABBREVIATED SYMBOL:

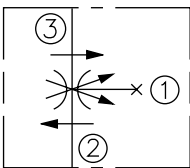

PERFORMANCE

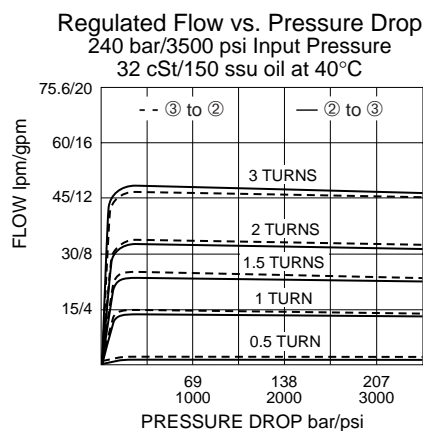
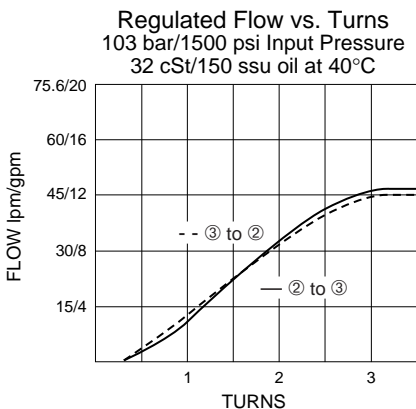

Bi-Directional

FR12-32

DIMENSIONS

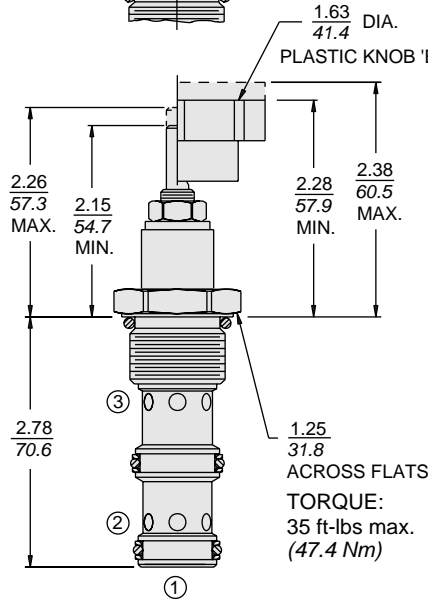
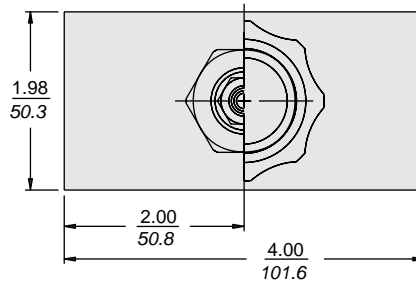
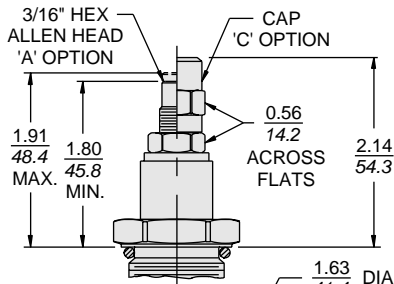

Patent Pending

INCH
MILLIMETRE

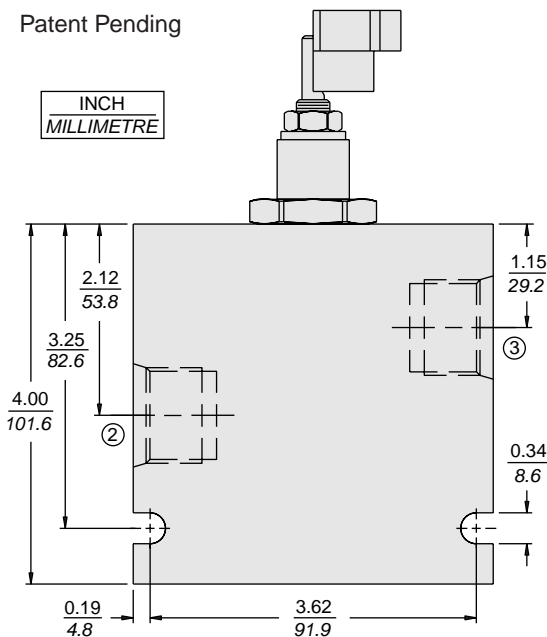

MATERIALS

Cartridge: Weight: 0.38 kg. (0.8 lbs.)
Steel with hardened work surfaces.
Zinc-plated exposed surfaces.
Buna N O-rings and polyester elastomer back-ups standard.

Standard Ported Body: Weight: 1.09 kg. (2.4 lbs.)
Anodized high-strength 6061 T6 aluminum alloy, rated to 207 bar (3000 psi). Ductile iron bodies available; dimensions may differ. See page 8.012.1

TO ORDER

FR12-32 - -

Adjustment Option

Extended Shaft Only Blank
3/16" Hex Allen Head **A**
Option 'A' w/Cover Cap **C**
Plastic Knob **E**

Seals

N Buna N (Std.)
V Fluorocarbon

Porting

Cartridge Only **0**
SAE 10 **10T**
SAE 12 **12T**
SAE 16 **16T**